

T 1-2 = 185.5
T 2-3 = 265.1

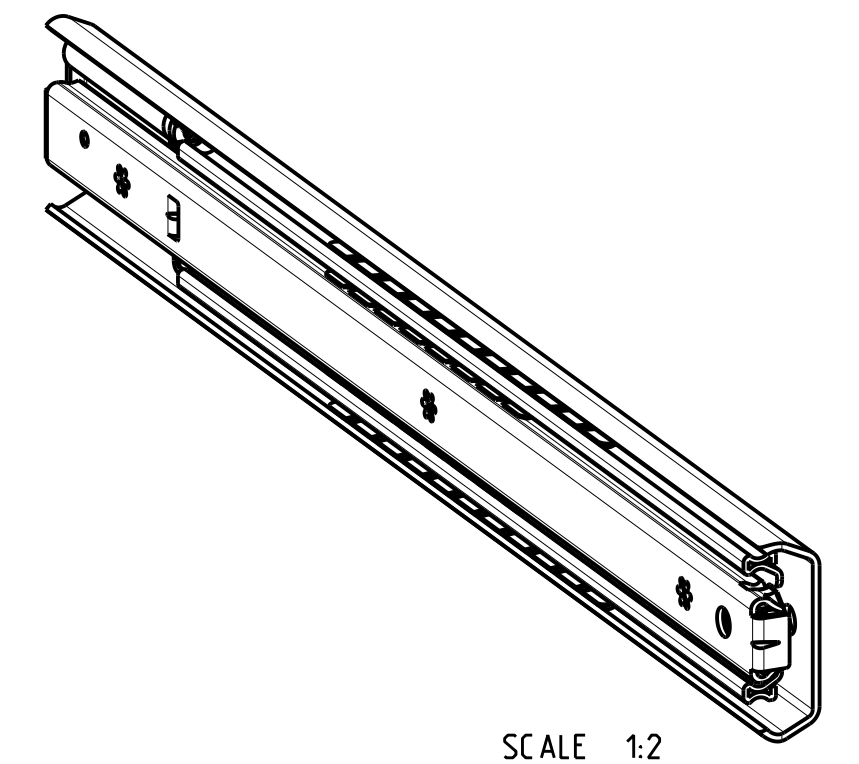

SCALE 1:2

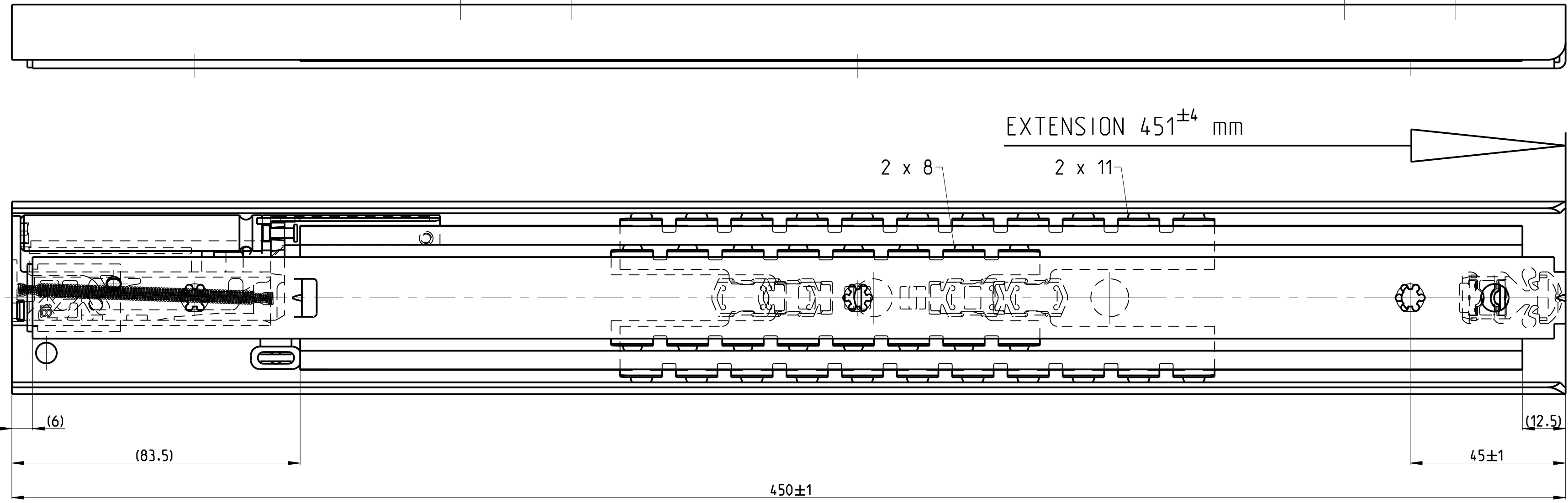
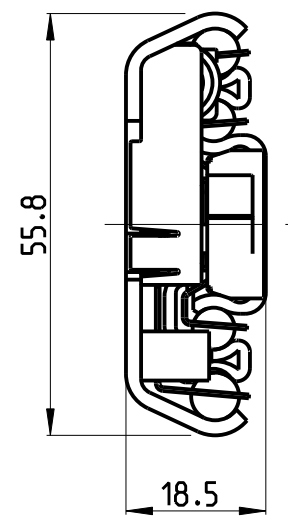
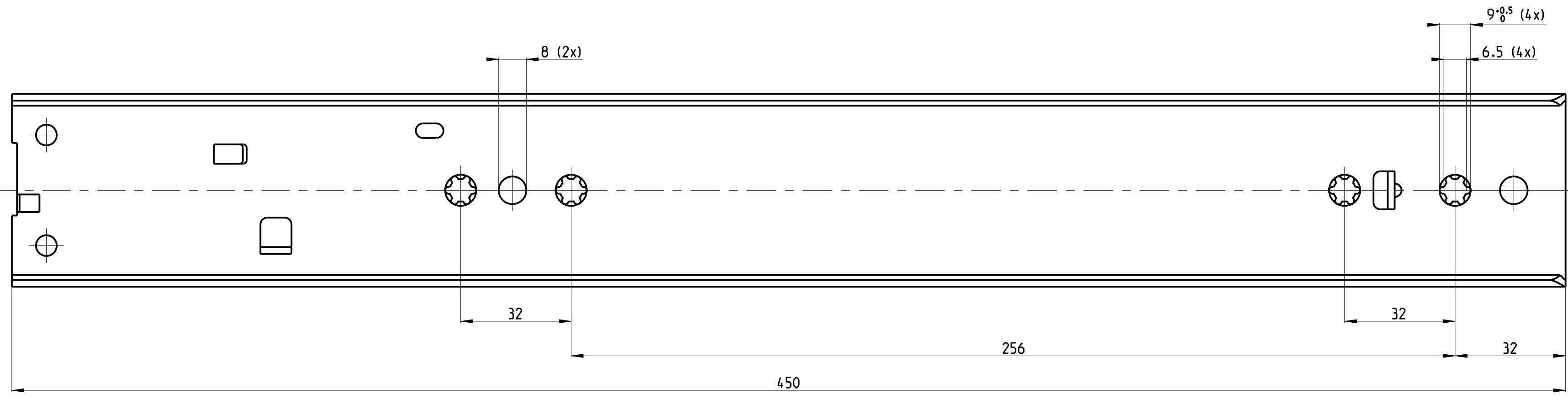
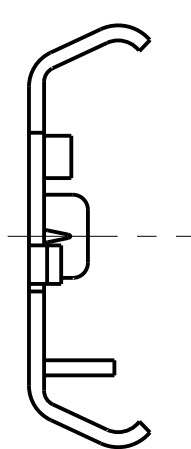

FRONT

511-12-R94-HDB

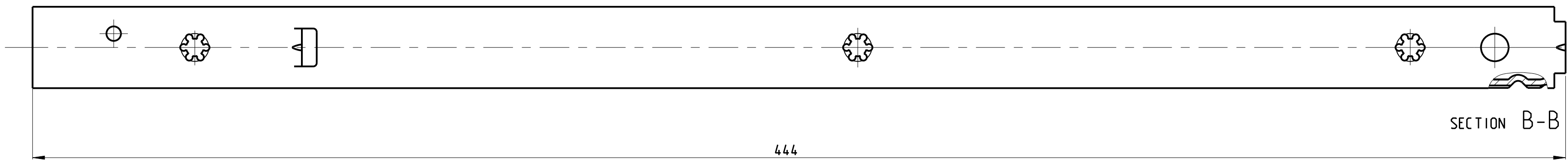
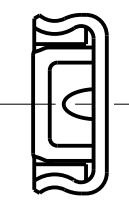

SECTION B-B

513-12-R94-UB3

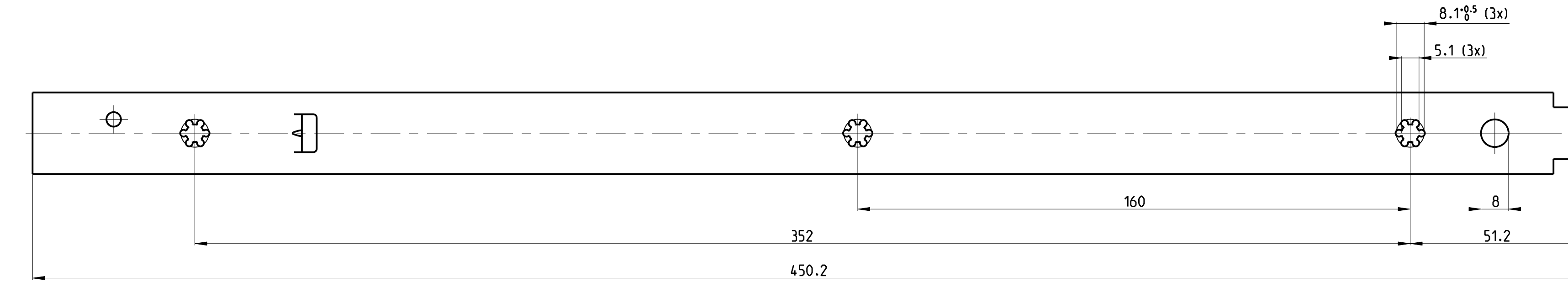

PRO/ENGINEER Drawing		Maten tussen haakjes zijn richtmaten. Toleranties tenzij anders vermeld ±0.5 mm.		Dimensions between marks are guide dimensions. Tolerances, unless otherwise stated ±0.5 mm.	
was: -					
Amerikaanse projectie	DIMENSION	mm	MAT.: -		
	SCALE	1:1	REM.: RIGHT HAND SLIDE = LEFT HAND SLIDE		
	DATE	01-04-2009	-		
	DESIGNER	Jo Bastings	-		
CHECKED	-	TYPE S			
ULF HD 450,0 / 450,6 (18,5mm)					
THOMAS REGOUT INTERNATIONAL BV			Tek. No.		Formaat.
AUTEURSRECHTEN VOORBEHOUDEN VOLGENS DE WET			112-R94 _ 01		A1
			Production		

04	-	-	-	-	05	-	-	-	-	06	-	-	-	-	-
01	24-6-'10	SOFTCLOSE	GEUPDATE	INT	R.G	02	-	-	-	03	-	-	-	-	-